



# VM Dual

Video Monitor



# USER MANUAL



Pixelhue Technology Ltd

Add: Kruisweg 643-647, 2132 NC, Hoofddorp,  
the Netherlands

Website: [www.pixelhue.com](http://www.pixelhue.com)

E-Mail: [info@pixelhue.com](mailto:info@pixelhue.com)



Document Version: V1.0.0.0



## Intellectual Property

Copyright © 2018 Pixelhue Technology Ltd. All rights reserved.  
No part of this document may be copied, reproduced, extracted or transmitted in any form or by any means without the prior written consent of Pixelhue Technology Ltd.

## Trademark

 **PIXELHUE** is a trademark of Pixelhue Technology Ltd.

## Statement

You are welcome to use the product of Pixelhue Technology Ltd. This document is intended to help you understand and use the product. For accuracy and reliability, Pixelhue Technology Ltd may make improvements and/or changes to this document at any time and without notice. If you experience any problems in use or have any suggestions, please contact us via contact information given in document. We will do our best to solve any issues, as well as evaluate and implement any suggestions.

# Table of contents

1. Overview	.....	P1
1.1 Positioning	.....	P1
1.2 Features	.....	P1
1.3 Dimensions	.....	P2
2. Appearance	.....	P3
2.1 Front Panel	.....	P3
2.2 Rear Panel	.....	P4
3. Signal Connection	.....	P5
4. Operations	.....	P6
4.1 Menu Operations	.....	P6
4.2 Video Source Switching	.....	P11
4.3 Aspect Ratio Switching	.....	P11
4.4 Test Pattern	.....	P11
4.5 TALLY Connector	.....	P12
5. Specifications	.....	P14

# 1 Overview

## 1.1 Positioning

The VM Dual is a video monitoring device with a compact rack mount design. It is equipped with two independent 7" TFT displays, and supports SDI, HDMI and DVI connectors.

The VM Dual can be installed in flight cases, outside broadcast vans, equipment racks, film editing workshops and other places requiring high quality video monitoring, which is ideal for post-production, broadcasting and on-site monitoring, as well as video input monitoring.

## 1.2 Features

- Supports multiple signal loop output functions and provides SDI, HDMI and DVI connectors.
- Supports up to 6 × inputs/loop outputs.
- Adopts 2 × 7" TFT HD LCD displays, with the resolution up to 1280 × 800.
- Supports multiple test patterns.
- Supports switching between different aspect ratios (auto fit/16:9/4:3).
- Supports easy input source switching.
- Supports EDID transparent transmission.

## 1.3 Dimensions

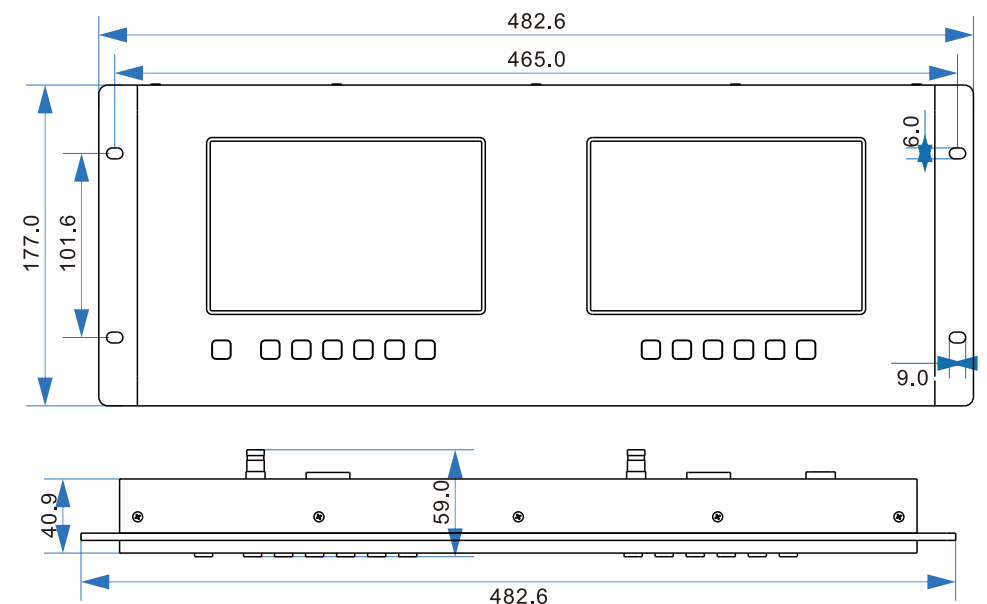

Unit: mm

# 2 Appearance

## 2.1 Front Panel

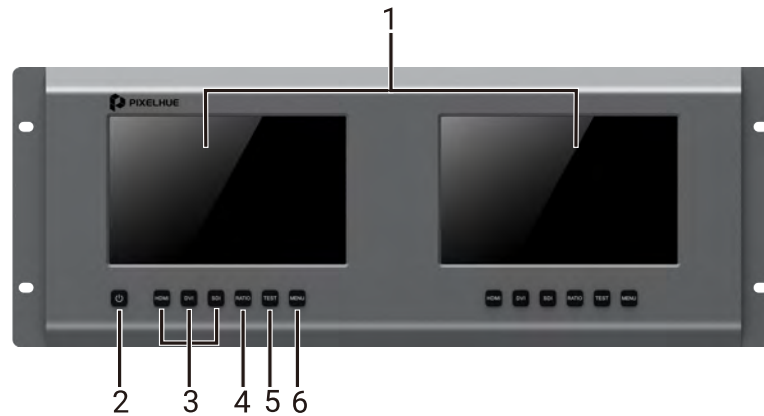

No.	Item	Description
1	TFT screens	Two 7" screens are used to display the content of the input source currently selected or menu items.
2	Power button	<ul style="list-style-type: none"> <li>Press the button to power on the device.</li> <li>Hold down the button to power off the device.</li> </ul>
3	Input source buttons	HDMI, DVI and SDI buttons for switching the input source.
4	RATIO	<ul style="list-style-type: none"> <li>On the video playback screen, press the button to switch between different aspect ratios (auto fit/16:9/4:3).</li> <li>On the menu screen, the button may have different functions in different submenus.</li> </ul>
5	TEST	<ul style="list-style-type: none"> <li>On the video playback screen, press the button to display the test patterns.</li> <li>On the menu screen, the button may have different functions in different submenus.</li> </ul>
6	MENU	<ul style="list-style-type: none"> <li>On the video playback screen, the button is a menu button.</li> <li>On the menu screen, the button may have different functions in different submenus.</li> </ul>

## 2.2 Rear Panel



Input		
Connector	Quantity	Description
HDMI IN	2	Each supports input resolutions up to 1920×1080@60Hz and downward compatibility.
DVI IN	2	Each supports input resolutions up to 1920×1080@60Hz and downward compatibility.
SDI IN	2	Supports 3G-SDI, HD-SDI and SD-SDI, with the input resolutions up to 1920×1080@60Hz, and downward compatibility.x
Loop Output		
Connector	Quantity	Description
HDMI LOOP	2	HDMI loop output
DVI LOOP	2	DVI loop output
SDI LOOP	2	SDI loop output
Control		
Connector	Quantity	Description
ETHERNET	1	Communicate with the control PC or update the system.
TALLY	1	Identifie the properties of the input source.
Power		
Power connector	DC 12 V (outer polarity: negative; inner polarity: positive)	

# 3 Signal Connection

# 4 Operations

Figure 3-1 shows the signal connection of the VM Dual. Please refer to the connector descriptions in 2.2 Rear Panel to connect the required hardware devices.

Figure 3-1 VM Dual signal connection



## 4.1 Menu Operations

### 4.1.1 Button Descriptions

Press the **MENU** button to enter the menu operation screen. On the menu operation screen, the **SDI**, **RATIO**, **TEST** and **MENU** buttons correspond to the icon buttons displayed on the screen and have different functions accordingly. For the detailed corresponding relationships, please refer to Figure 4-1.

Figure 4-1 Button corresponding relationship



	Exit the menu screen		Enter the editing status
	Move the cursor downward		Decrease the parameter value
	Move the cursor upward		Increase the parameter value
	Move the cursor rightward		OK
	Move the cursor leftward		

## 4.1.2 Display

### Operating Procedure

**Step 1** Press the **MENU** button to enter the menu operation screen as shown in [Figure 4-2](#).

Figure 4-2 Menu operation screen

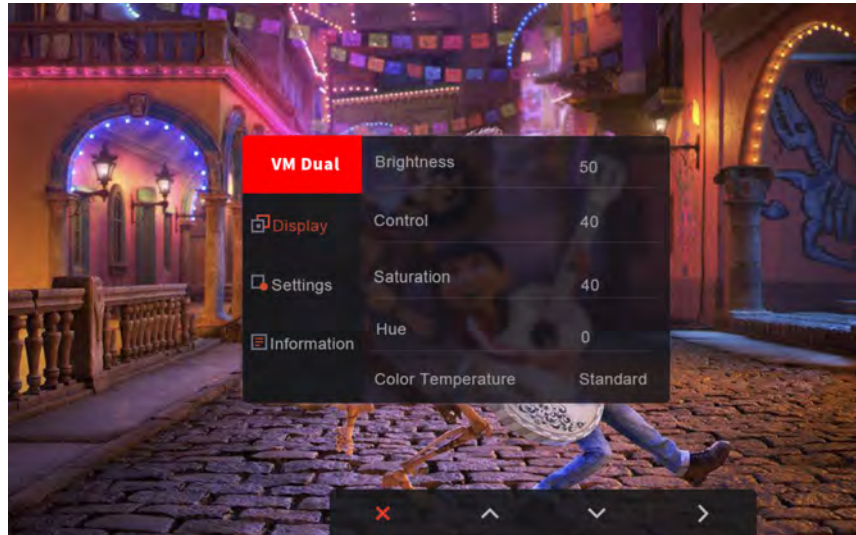

- Step 2** Press the **MENU** button to enter the submenu to set the parameters.
- Step 3** Press the **RATIO** or **TEST** button to move upward or downward to select the desired parameter.
- Step 4** Press the **MENU** button to confirm the selection.
- Step 5** Press the **RATIO** or **TEST** button to increase or decrease the parameter value.
- Step 6** Press the **MENU** button to confirm the setting.

For detailed display parameter settings, please refer to [Table 4-1](#).

Table 4-1 Parameter settings

Name	Value Range	Description
Brightness	0–100	Adjust the screen brightness. The larger this value is, the brighter the screen will be. The default value is 50.
Contrast	0 – 100	Adjust the difference between the darkest and brightest areas of the image displayed on the screen. The larger this value is, the bigger this difference will be. The default value is 50.
Saturation	0 – 100	Adjust the purity or vividness grade of the image color. The larger this value is, the purer the color will be. The default value is 50.
Hue	-180 - 180	Adjust the gradation or variety of the image color. The larger this value is, the intenser the color will be. The default value is 0.
Color temperature	<input type="checkbox"/> Standard <input type="checkbox"/> Cool <input type="checkbox"/> Warm	Adjust the warmth or coolness of the image color. Cool colors are close to the sea, but warm colors are close to the sun. The default setting is Standard.
Image mode	<input type="checkbox"/> Standard <input type="checkbox"/> Mild <input type="checkbox"/> Bright <input type="checkbox"/> Custom	Adjust the color mode of the image displayed on the screen. The default setting is Custom.

**Note:**  
The item where the cursor moves is orange, and the item which is being adjusted is blue.

## 4.1.3 Settings

### Operating Procedure

**Step 1** Press the **MENU** button to enter the menu operation screen, and then press the **TEST** button to move downward to select **Settings** as shown in [Figure 4-3](#).



Figure 4-3 Settings

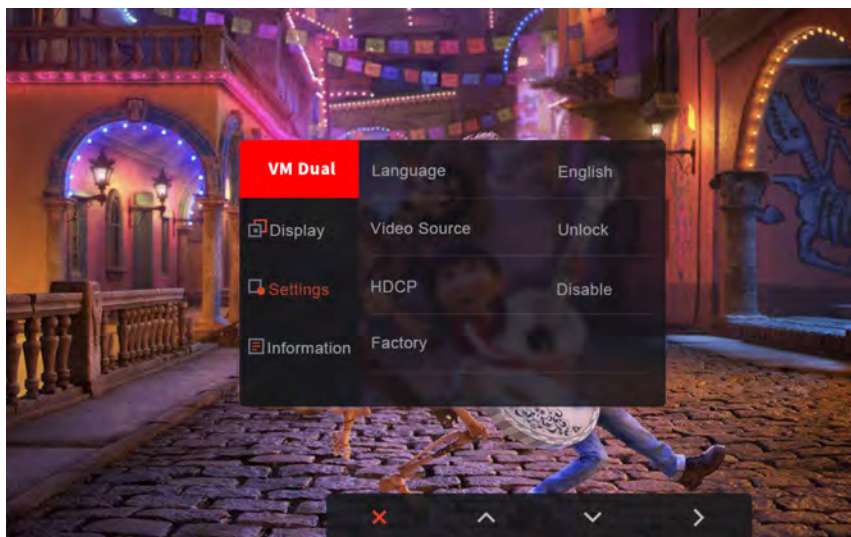

- Step 2 Press the **MENU** button enter the submenu to set the parameters.
- Step 3 Press the **RATIO** or **TEST** button to move upward or downward to select the desired parameter.
- Step 4 Press the **MENU** button to confirm the selection.
- Step 5 Press the **RATIO** or **TEST** button to increase or decrease the parameter value.
- Step 6 Press the **MENU** button to confirm the setting.

For detailed display parameter settings, please refer to [Table 4-2](#).

Table 4-2 Parameter settings

Name	Value Range	Description
Language	<ul style="list-style-type: none"> <li>■ English</li> <li>■ Chinese</li> </ul>	Change the UI language.
Video source	<ul style="list-style-type: none"> <li>■ Lock</li> <li>■ Unlock</li> </ul>	Set to whether to show the video source information on the screen or not.
HDCP	<ul style="list-style-type: none"> <li>■ Enable</li> <li>■ Disable</li> </ul>	HDCP (High-bandwidth Digital Content Protection) supports HDCP-encrypted HDMI input, but does not support HDCP-encrypted loop output. It is disabled by default.
Factory reset	—	Reset the device to factory settings.

#### 4.1.4 Information

Press the **MENU** button to enter the menu operation screen, and then press the **TEST** button to move downward to select **Information** as shown in [Figure 4-4](#). Then you can view the IP address, subnet mask, gateway and software version.

Figure 4-4 Information

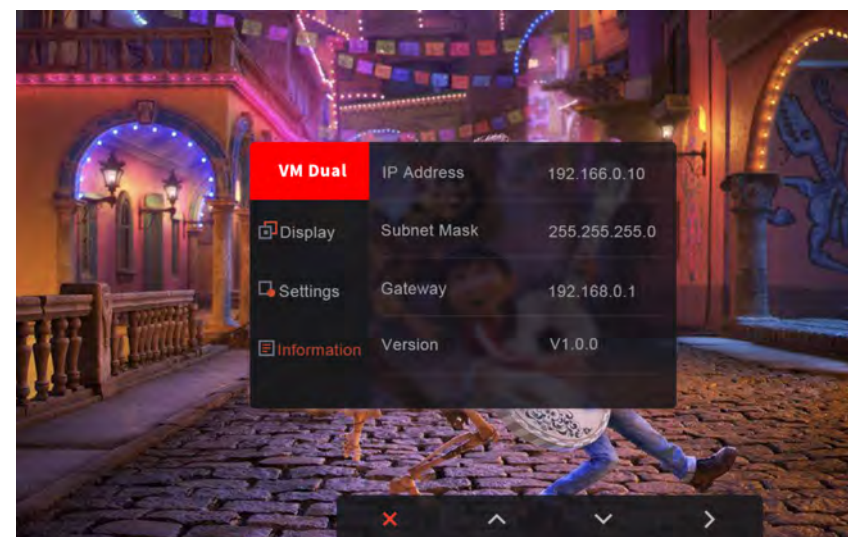

## 4.2 Video Source Switching

Item	Operation
Switch to HDMI	On the video playback screen, press the <b>HDMI</b> button to switch to the HDMI video source.
Switch to DVI	On the video playback screen, press the <b>DVI</b> button to switch to the DVI video source.
Switch to SDI	On the video playback screen, press the <b>SDI</b> button to switch to the SDI video source.

### Note:

After the video source is successfully switched, it will be displayed on the top left of the screen.

## 4.3 Aspect Ratio Switching

Default	The aspect ratio is full screen by default.
Operation	On the video playback screen, press the <b>RATIO</b> button to switch between different aspect ratios.
Description	Press the <b>RATIO</b> button repeatedly to switch between different aspect ratios. The sequence is full screen, 16:9 and 4:3. After the aspect ratio is successfully switched, it will be displayed on the top right of the screen.

## 4.4 Test Pattern

Enter the test pattern	On the video playback screen, press the <b>TEST</b> button to enter the test pattern.
Exit the test pattern	Hold down the <b>TEST</b> button to exit the test pattern. Press the <b>TEST</b> button repeatedly to switch to the normal display. Press the <b>RATIO</b> button. Press the input source button.
Operation description	Press the <b>TEST</b> button repeatedly to switch between different test patterns. The sequence is red, green, blue, white, black, grayscale and normal display.

## 4.5 TALLY Connector

The TALLY connector is used to identify the properties of the input source. You can use it according to the actual situation. The connector diagram is shown in [Figure 4-5](#).

Figure 4-5 TALLY connector

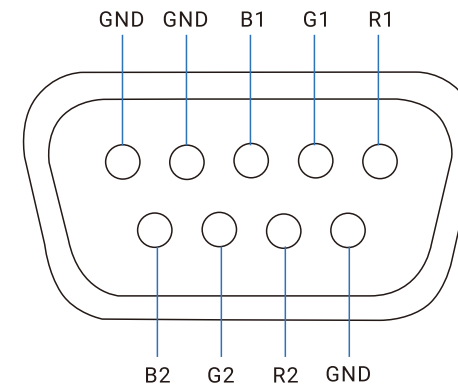

The supported VCC voltage of the TALLY connector pins is 5 V. When low-level signals are sent to the pins, the screens will display colored rectangle frames. B1, G1 and R1 control the left screen, while B2, G2 and R2 control the right screen. Here take the left screen as an example. The detailed pin definitions are shown in [Table 4-3](#).



# 5 Specifications

Table 4-3 B1, G1 and R1 pin definitions

B1	G1	R1	Color
GND	VCC	VCC	Blue
VCC	GND	VCC	Green
VCC	VCC	GND	Red
GND	GND	VCC	Cyan
GND	VCC	GND	Magenta
VCC	GND	GND	Yellow
GND	GND	GND	White
VCC	VCC	VCC	Black

**Example:**  
To display blue frame on the left screen, send a low-level signal to the B1 pin and keep the G1 and R1 pins staying on high level.

Input	Description
HDMI	HDMI 1.3, EIA/CEA-861 compliant
DVI	VESA-compliant, 1080p input source supported
SDI	3G-SDI, HD-SDI, SD-SDI
Loop Output	Description
HDMI LOOP	HDMI loop output
DVI LOOP	DVI loop output
SDI LOOP	SDI loop output
Overall Specifications	Description
Power supply	DC 12 V (outer polarity: negative; inner polarity: positive)
Max. video width	3840
Max. video height	3840
Min. video width	800
Min. video height	600
Storage temperature	-20°C to +60°C
Operating temperature	0°C to 50°C
Operating humidity	10% RH to 90% RH
Dimensions	482.6 mm × 177.0 mm × 41.0 mm
Max. Power consumption	24 W
Net weight	2.90 kg